

Team Update 21

GENERAL

- **Last One:** *Team Update 21* is the final Team Update of the 2019 DESTINATION: DEEP SPACE Powered By The Boeing Company season.
- **Q&A:** The official 2019 Q&A will close at noon (Eastern) on Wednesday, April 10, 2019.

MANUAL

SECTION 8.2.4

- G15. Be careful about what you interact with.** DRIVE TEAMS, ROBOTS, and OPERATOR CONSOLES are prohibited from the following actions with regards to interaction with ARENA elements. Items A-D exclude GAME PIECES and the HAB PLATFORM.
- A. Grabbing (excluding DRIVE TEAM interaction with FIELD ARENA elements in their areas)
 - B. Grasping (excluding DRIVE TEAM interaction with FIELD ARENA elements in their areas)
 - C. Attaching (including the use of hook tape to anchor to the FIELD carpet and excluding use of the PLAYER STATION hook-and-loop tape, plugging in to the provided power outlet, and plugging the provided Ethernet cable in to the OPERATOR CONSOLE)
 - D. Hanging
 - E. Deforming
 - F. Becoming entangled
 - G. Damaging
 - H. Repositioning GAME PIECE holders (incidental movement where their general position is unchanged is an exception)

Violation: If prior to MATCH, and situation can be corrected quickly, it must be remedied before the MATCH will start. If during a MATCH, FOUL. If during a MATCH and extended or repeated, YELLOW CARD. If offense is via a ROBOT and the Head REFEREE determines that further damage is likely to occur, offending ROBOT will be DISABLED. Corrective action (such as eliminating sharp edges, removing the damaging MECHANISM, and/or re-Inspection) may be required before the ROBOT will be allowed to compete in subsequent MATCHES.

GAME PIECES are expected to undergo a reasonable amount of wear and tear as they are handled by ROBOTS, such as scratching or marking. Gouging, tearing off pieces, popping, or routinely marking GAME PIECES are violations of this rule. Materials that aggressively wear or leave behind residue or debris on the HATCH PANEL'S loop tape may hinder the natural behavior of the loop tape and thus violate G15. Humans causing GAME PIECE wear and tear, e.g. deforming a CARGO, are subject to a CARD per C1.

There are no rules that prohibit contact with the SANDSTORM'S black out material, however contact that prevents the SANDSTORM from working properly (e.g. retracting at T-minus 135s) is considered damaging and a violation of G15.



Team Update 20

MANUAL

SECTION 5.3

Except for the SANDSTORM bonuses, scores are based on the state of the FIELD when the ARENA timer displays zero (0), ~~or, if not all elements have come to rest or the ROBOT changes state after being DISABLED at the end of the MATCH, five (5) seconds after the ARENA timer displays zero (0).~~ However, if GAME PIECES are in motion when the ARENA timer displays zero (0), GAME PIECE scores are assessed once they come to rest. Additionally, if a ROBOT is in motion when the ARENA timer displays zero (0) or moves immediately after becoming DISABLED, its score is evaluated five (5) seconds after the ARENA timer displays zero (0).

SECTION 5.5

A DRIVE TEAM is a set of up to five (5) people from the same FIRST Robotics Competition team responsible for team performance for a specific MATCH. There are four (4) specific roles on a DRIVE TEAM which ALLIANCES can use to assist ROBOTS with DESTINATION: DEEP SPACE.

The intent of the definition of DRIVE TEAM and DRIVE TEAM related rules is that, barring extenuating circumstances, the DRIVE TEAM consists of people who arrived at the event affiliated with that team and are responsible for their team's and ROBOT'S performance at the event (this means a person may be affiliated with more than one (1) team). The intent is not to allow teams to "adopt" members of other teams for strategic advantage for the loaning team, borrowing team, and/or their ALLIANCE (e.g. an Alliance Captain believes one of their DRIVERS has more experience than a DRIVER on their 1st pick, and the teams agree the 1st pick team will "adopt" that DRIVER and make them a member of their DRIVE TEAM for Playoffs).

The definition isn't stricter for two main reasons. First, to avoid additional bureaucratic burden on teams and event volunteers (e.g. requiring that teams submit official rosters that queuing must check before allowing a DRIVE TEAM in to the ARENA). Second, to provide space for exceptional circumstances that give teams the opportunity to display Gracious Professionalism (e.g. a bus is delayed, a COACH has no DRIVERS, and their pit neighbors agree to help by loaning student DRIVERS as temporary members of the team until their bus arrives).

SECTION 8.2.5

G20. Stay out of other ROBOTS. Initiating deliberate or damaging contact with an opponent ROBOT on or inside the vertical extension of its FRAME PERIMETER, including transitively through a GAME PIECE, is not allowed.

Violation: TECH FOUL and YELLOW CARD.

High speed accidental collisions may occur during the MATCH and are expected. Generally, ROBOTS extend elements outside of the FRAME PERIMETER at their own risk.

A ROBOT with an element outside its FRAME PERIMETER may be penalized under G20 if it appears they are using that element to purposefully contact another ROBOT inside its FRAME PERIMETER.

The "deliberate or damaging" clause in G20 refers specifically to whether the actual contact within/on an opponent's FRAME PERIMETER is deliberate or damaging, not with any actions/game play/intentions leading up to that contact.

Generally, if, in the judgement of the REFEREE, contact on/within a ROBOT'S FRAME PERIMETER is neither deliberate nor damaging, G20 is not violated. Examples include

- a ROBOT hits an opponent to move it away from its ROCKET and tilts in a way that part of it swings, accidentally in the REFEREE'S judgement, in to an opponent's FRAME PERIMETER and makes contact but causes no damage.



- a ROBOT tries to push an opponent by hitting them on their BUMPER, but because of the impact, accidentally (in the REFEREE'S judgement) rolls on top of them such that their wheels are in contact with elements inside the opponent's FRAME PERIMETER but causes no damage.

An example of a violation of G20 is if a ROBOT reaches inside an opponent's FRAME PERIMETER and uses their arm to hit the opponent's gripper to make the opponent drop their GAME PIECE.

SECTION 10.4

R20. Teams must stay “hands-off” their bagged ROBOT elements during the following time periods:

...

G. Teams attending 2-day events may access their ROBOTS using the ROBOT Access Period.

Teams attending 2-day events will not have as much time to work on their ROBOTS at events as teams attending traditional 3-day Regional events. Due to this, teams are granted an additional “ROBOT Access Period” to un-bag their ROBOT between the “Stop Build Day” and their 2-day district events. 2-day events for the 2019 season include District Qualifier events for the following areas/events:

- *FIRST* Chesapeake District (DC, MD, VA)
- *FIRST* Israel District (IS)
- *FIRST* in Michigan District (MI)
- *FIRST* Mid-Atlantic District (DE, NJ, Eastern PA)
- *FIRST* North Carolina District (NC)
- *FIRST* in Texas (TX, NM)
- Indiana *FIRST* District (IN)
- NE *FIRST* District (CT, MA, ME, NH, RI, VT)
- Ontario District (ON)
- Pacific Northwest (AK, OR, WA)
- Peachtree District (GA)
- *FIRST* North Carolina State Championship
- Indiana State Championship

SECTION 12.2.1

All YELLOW CARDS are cleared in FMS at the conclusion of Practice, and Qualification, Sub-Division Playoff, and Division Playoff MATCHES. The Head REFEREE may opt to perpetuate a YELLOW CARD earned during Practice MATCHES through to Qualification MATCHES for particularly egregious behavior.



Team Update 19

MANUAL

No changes.

GENERAL

No changes.



Team Update 18

MANUAL

SECTION 8.2.3

- G9. One (1) defender at a time.** No more than one ROBOT may be positioned such that its BUMPERS break the plane defined by or are completely beyond the opponent's CARGO SHIP LINE.

The exception to this rule is if an additional ROBOT

- A. is forced to cross the opponent's CARGO SHIP LINE by an opponent ROBOT (e.g. it is pushed over the opponent's CARGO SHIP LINE by an opponent in a defensive effort to prevent them from scoring a CARGO in a ROCKET), and
- B. makes a dedicated effort to cross back over the CARGO SHIP LINE until no more than one ROBOT is positioned such that its BUMPERS break the plane defined by or are completely beyond the opponent's CARGO SHIP LINE.

Violation: FOUL, plus an additional FOUL for every five (5) seconds in which the situation is not corrected. If G10 is also being violated, additional FOUL escalates to TECH FOUL.

Only one (1) 'five-count' will be maintained at a time for G9, G10, and G18. For violations of G9/G10, the first count started will be maintained and a FOUL or TECH FOUL will be assessed at each five-second interval depending on whether one or both rules are being violated. If G18 is also violated, REFEREES are instructed to disregard G9/G10 counts to focus on the pin. Attempts to intentionally manipulate this in order to avoid G9/G10 penalties may be subject to YELLOW/RED CARDS for egregious behavior.

- G10. On defense, rein it in.** No part of a ROBOT, except its BUMPERS, may be outside its FRAME PERIMETER if its BUMPERS are completely beyond its opponent's CARGO SHIP LINE.

The exception to this rule is if the ROBOT

- A. is forced to cross the opponent's CARGO SHIP LINE by an opponent ROBOT (e.g. it is pushed over the opponent's CARGO SHIP LINE by an opponent in a defensive effort to prevent them from scoring a CARGO in a ROCKET), and
- B. makes a dedicated effort to reposition itself such that
 - i. its BUMPERS are not completely beyond its opponent's CARGO SHIP LINE or
 - ii. the ROBOT is contained to its FRAME PERIMETER.

Violation: FOUL, plus an additional FOUL for every five (5) seconds in which the situation is not corrected. If G9 is also being violated, additional FOUL escalates to TECH FOUL.

SECTION 10.8

- R73.** The DRIVER Station software, roboRIO, Power Distribution Panel, Pneumatics Control Modules, Voltage Regulator Modules, RSL, 120A breaker, motor controllers, relay modules (per R36-B), Wireless Bridge, and batteries shall not be tampered with, modified, or adjusted in any way (tampering includes drilling, cutting, machining, rewiring, disassembling, painting, etc.), with the following exceptions:

Please note that the DRIVER Station application is a separate application from the Dashboard. The DRIVER Station software may not be modified, while teams are expected to customize their Dashboard code.

- A. User programmable code in the roboRIO may be customized.
- B. Motor controllers may be calibrated as described in owner's manuals.
- C. Fans may be attached to motor controllers and may be powered from the power input terminals.
- D. If powering the compressor, the fuse on a Spike H-Bridge Relay may be replaced with a 20A Snap-Action circuit breaker.



- E.** Wires, cables, and signal lines may be connected via the standard connection points provided on the devices.
- F.** Fasteners (including adhesives) may be used to attach the device to the OPERATOR CONSOLE or ROBOT or to secure cables to the device.
- G.** Thermal interface material may be used to improve heat conduction.
- H.** Labeling may be applied to indicate device purpose, connectivity, functional performance, etc.
- I.** Jumpers may be changed from their default location.
- J.** Limit switch jumpers may be removed from a Jaguar motor controller and a custom limit switch circuit may be substituted.
- K.** Device firmware may be updated with manufacturer supplied firmware.
- L.** Integral wires on motor controllers may be cut, stripped, and/or connectorized.
- M.** Devices may be repaired, provided the performance and specifications of the device after the repair are identical to those before the repair.
- N.** The cover may be removed from the Talon SRX data port.
- O.** Electrical tape may be applied to the aluminum plate inside the Wireless Bridge.
- P.** The input terminal cover from the Power Distribution Panel may be omitted (no other element may be installed using the threaded holes to install something in place of the PDP terminal cover).

Please note that while repairs are permitted, the allowance is independent of any manufacturer's warranty. Teams make repairs at their own risk and should assume that any warranty or RMA options are forfeited. Be aware that diagnosing and repairing COMPONENTS such as these can be difficult.

For more information about modification O, please see [this article](#).



Team Update 17

MANUAL

SECTION 9.2.1

H10. No peeking. During the SANDSTORM PERIOD, COACHES, DRIVERS, and HUMAN PLAYERS may not look over the top of the ALLIANCE WALL **down to the FIELD** to overcome the effect of the SANDSTORM.

SECTION 10.8

R73. The DRIVER Station software, roboRIO, Power Distribution Panel, Pneumatics Control Modules, Voltage Regulator Modules, RSL, 120A breaker, motor controllers, relay modules (per R36-B), Wireless Bridge, and batteries shall not be tampered with, modified, or adjusted in any way (tampering includes drilling, cutting, machining, rewiring, disassembling, painting, etc.), with the following exceptions:

Please note that the DRIVER Station application is a separate application from the Dashboard. The DRIVER Station software may not be modified, while teams are expected to customize their Dashboard code.

- A. User programmable code in the roboRIO may be customized.
- B. Motor controllers may be calibrated as described in owner's manuals.
- C. Fans may be attached to motor controllers and may be powered from the power input terminals.
- D. If powering the compressor, the fuse on a Spike H-Bridge Relay may be replaced with a 20A Snap-Action circuit breaker.
- E. Wires, cables, and signal lines may be connected via the standard connection points provided on the devices.
- F. Fasteners (including adhesives) may be used to attach the device to the OPERATOR CONSOLE or ROBOT or to secure cables to the device.
- G. Thermal interface material may be used to improve heat conduction.
- H. Labeling may be applied to indicate device purpose, connectivity, functional performance, etc.
- I. Jumpers may be changed from their default location.
- J. Limit switch jumpers may be removed from a Jaguar motor controller and a custom limit switch circuit may be substituted.
- K. Device firmware may be updated with manufacturer supplied firmware.
- L. Integral wires on motor controllers may be cut, stripped, and/or connectorized.
- M. Devices may be repaired, provided the performance and specifications of the device after the repair are identical to those before the repair.
- N. The cover may be removed from the Talon SRX data port.
- O. Electrical tape may be applied to the aluminum plate inside the Wireless Bridge.
- P. **The input terminal cover from the Power Distribution Panel may be omitted.**

Please note that while repairs are permitted, the allowance is independent of any manufacturer's warranty. Teams make repairs at their own risk and should assume that any warranty or RMA options are forfeited. Be aware that diagnosing and repairing COMPONENTS such as these can be difficult.

For more information about modification O, please see [this article](#).

SECTION 12.8.2

Table 12-8 2019 District Championship Capacities

District Championship	Capacity
FIRST Chesapeake District Championship	60 58
FIRST Israel District Championship	45



<i>FIRST</i> Mid-Atlantic District Championship	60
<i>FIRST</i> North Carolina State Championship	32
<i>FIRST</i> Ontario Provincial Championship	80
<i>FIRST</i> in Texas District Championship	64
Indiana State Championship	32
Michigan State Championship	160
New England District Championship	64
Pacific Northwest District Championship	64
Peachtree District State Championship	45



Team Update 16

GENERAL

- We have reports of teams having issues with cameras streaming at Week 1 events, particularly teams using LabVIEW on the robot. We will be preparing FTAs and CSAs for Week 2 events with best practices for troubleshooting based on what we saw Week 1 and see in additional testing we are currently performing. We also plan to publish additional troubleshooting information for teams as soon as possible.

MANUAL

SECTION 5.3

For the purposes of assessing SANDSTORM and HAB Climb Bonuses described in Table 5-1, a ROBOT is considered to have started from, or climbed to, a HAB Level if:

1. the ROBOT'S BUMPERS are fully above the Level's platform and
2. the ROBOT is only supported by:
 - surfaces of the HAB PLATFORM at or above that Level (including transitively through a GAME PIECE),
 - ALLIANCE WALL, and/or
 - another ROBOT which has climbed to that HAB Level or higher

Table 5-1 DESTINATION: DEEP SPACE scoring opportunities

Award	Awarded for...	Value
CARGO	each CARGO partially or completely (regardless of inflation state) in a BAY with a Null HATCH PANEL or scored HATCH PANEL and not in contact with a ROBOT from that ROCKET/CARGO SHIP'S ALLIANCE. No more than one CARGO per BAY will be counted.	3

SECTION 9.3

H16. Don't bang on the glass. Team members may never strike or hit the ALLIANCE PLAYER STATION plastic windows.

Violation: Verbal warning. If subsequent violations, YELLOW CARD.

SECTION 12.3

All reasonable effort is made to create the same conditions when replaying a MATCH. This means, for example, that a team that was BYPASSED during prior to the start of the MATCH which is to be replayed, is BYPASSED for the replay MATCH.

Note that an ARENA FAULT that does not affect MATCH outcome in the judgement of the Head REFEREE does not lead to a MATCH replay. Examples include, but are not limited to:

- a. a piece of FIELD plastic falls into the FIELD, far away from any human or ROBOT activity, and in such a way that it does not affect MATCH outcome
- a. delay in the playing of an ARENA sound
- b. mismatch between the timer on the Audience Screen and the ARENA Timer
- c. any adjustment or delay in assignment of a penalty (including those made after the MATCH)



Team Update 15

GENERAL

- **Inspection Checklist:** Version 3.0 of the [2019 Inspection Checklist](#) has been posted with edits as follows:
 - The RoboRio image (~~FRC_2019_v12~~ [FRC_roboRIO_2019_v14](#) or later) (per [Team Update 14](#))
 - Arabic Font **Numeral**
- **Fair Market Value of pre-2019 FIRST Choice items:** It's come to our attention that there were valuable items available to teams in previous seasons' Kickoff Kits and *FIRST* Choice whose Fair Market Value exceeds the limit set in R13 (e.g. the [Analog Devices MXP IMU](#)). This was an oversight on our part, and not at all the intent. We're sorry for this unintended consequence and for confusion this may have caused. We'll be reassessing this set of rules after the season with this factor in mind, but meanwhile need to put a fix in place to make sure teams aren't inhibited for the 2019 season; see the edit to R14 below.

Thank you to all donors who make their items available to teams!

- **Control System:** An optional WPILib update 2019.4.1 has been released. This update addresses a SPI bug that inhibited communication with the Analog Devices ADIS16470. A full changelog and download links can be found on the [WPILib Github](#).

MANUAL

SECTION 4.1

Each FIELD for DESTINATION: DEEP SPACE is a 27 ft. (~823 cm) by 54 ft. (~1646 cm) carpeted area bound by and including the inward- and upward-facing surfaces of the guardrails, inward-facing surfaces of the ALLIANCE WALLS (except Chute surfaces).

SECTION 8.2.2

- G4. One GAME PIECE at a time.** ROBOTS may not have ~~extended~~ greater-than-momentary or repeated control, i.e. exercise ~~extended~~ greater-than-momentary or repeated influence, of more than one (1) GAME PIECE at a time, either directly or transitively through other objects. A GAME PIECE that is at least partially supported by a ROCKET or CARGO SHIP is not considered controlled by the ROBOT.

Violation: FOUL per additional GAME PIECE. If strategic, YELLOW CARD.

If a GAME PIECE becomes lodged in or on a ROBOT, it is considered controlled by the ROBOT. It is important to design your ROBOT so that it is impossible to inadvertently or unintentionally control more than the allowed maximum.

Example 1: If a ROBOT controls two (2) GAME PIECES and then releases them all in a way that both GAME PIECES are in scoring position, the team is issued a YELLOW CARD.

Example 2: If a CARGO is stuck on a ROBOT and that ROBOT picks up a HATCH PANEL, they are issued a FOUL per G4. If they place that HATCH PANEL and then pick up another HATCH PANEL, they are issued another FOUL. Continuing game play in this manner (i.e. not taking advantage of carrying more than one (1) GAME PIECE) would generally not be considered a strategic violation.

Example 3: A ROBOT controlling one (1) GAME PIECE that briefly contacts several CARGO in close proximity causing them to scatter would generally not be considered in violation of G4.

SECTION 9.2

- H7. GAME PIECES through LOADING STATIONS only.** During the MATCH, team members may only enter GAME PIECES on to the FIELD through their LOADING STATIONS (i.e. fed such that they go in the ALLIANCE STATION side and exit the LOADING STATION HATCH or FIELD side of the chute).

Violation: FOUL per GAME PIECE.



SECTION 10.4

R14. The BOM cost of each non-KOP item must be calculated based on the unit Fair Market Value for the material and/or labor, except for labor provided by team members (including sponsor employees who are members of the team), members of other teams, event provided Machine Shops and shipping.

Any Kickoff Kit or *FIRST* Choice item received by a team in or before the 2018 season that has a FMV over \$500 may be accounted at \$500 on the team's BOM.

SECTION 12.2.1

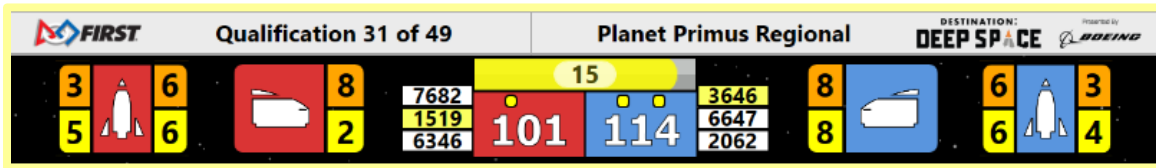

Figure 12-2 Audience Screen Graphic Showing YELLOW CARD Indicators



Team Update 14

GENERAL

- **Team Update Schedule:** For the remainder of the 2019 *FIRST* Robotics Competition season, Team Updates will only be posted on Tuesdays (i.e. no more Friday Team Updates).
- **Autodesk:** Assets on the [FIRST Robotics Education Community page](#) have been updated.
 - The 2019 KOP models are now available in both Autodesk Inventor and Fusion 360 formats.
 - Both the Inventor field model and Fusion 360 field model have been updated (as described in [Team Update 13](#))
 - Synthesis 4.2.2.0 has been released. The update includes the updated 2019 field (as described in [Team Update 13](#)) within the installation and updates to the code emulator to reduce lag.
- **Control System:** A required NI Update Suite (2019.2.0) with a new roboRIO image (FRC_roboRIO_2019_v14) [has been released](#). This image fixes a bug where robots randomly enter the Watchdog Not Fed state (disabling outputs) for ~2.5s when they should be enabled. To use this image, C++\Java teams must have the previously released 2019.3.2 update installed.

MANUAL

SECTION 10.8

- R64.** ROBOTS must be controlled via one (1) programmable National Instruments roboRIO (P/N: am3000), with image version ~~FRC_2019_v12~~ **FRC_roboRIO_2019_v14** or later.



Team Update 13

GENERAL

- **Inspection Checklist:** Version 2.0 of the [2019 Inspection Checklist](#) has been posted. It has been updated to include a HATCH PANEL launch check.
- **Drawings:** The [Field Drawings – season specific](#) drawing package includes updated GE-19131, GE-19133, GE-19137, GE-19138, GE-19156, GE-19157, & GE-19158 and adds GE-19251, GE-19252, & GE-19253 (changes propagate through affected parent assemblies and the [FIRST Official CAD Models](#)). Changes are noted on the drawings and were done to fix an issue seen at Week 0 where HATCH PANELS were binding between panels.

MANUAL

SECTION 4.3

A ROCKET is a 10 ft. 4 in. (~315 cm) tall assembly placed such that its centerline is 8 ft. (~244 cm) from the CENTER LINE, and its “front” face is parallel to the guardrail, faces its CARGO SHIP, and 2 ft. 3½ in. (~70 cm) from the guardrail. The distance from the front of the “front” face to the back of the “back” face is 1 ft. 7⅝ in. (~50 cm). The angle of its sides is 61¼ degrees. **Each ROCKET sits on top of a base; the base is not part of the ROCKET.**

SECTION 4.5

- The lowest deck, and the ramps, and the strips of ALLIANCE colored tape that trace the intersections of the ramps and the carpet form Level 1. The Level 1 deck is 3 in. (~8 cm) high by 10 ft. 8 in. (~325 cm) long by 3 ft. (~91 cm) deep. The ramps are 11½ in. (~29 cm) long with a 15-degree angle.

SECTION 5.1.1

Twenty-four (24) of each GAME PIECE are staged on each side of the ARENA for each MATCH as follows:

- one (1) HATCH PANEL is loaded in each of the two (2) LOADING STATIONS,
- six (6) CARGO are staged in each of the two (2) DEPOTS,
- each of the three (3) teams may preload one (1) HATCH PANEL or one (1) CARGO in their ROBOT such that it is fully supported by that ROBOT, and
- remaining HATCH PANELS (quantity 19-22, depending on decisions made in C) and CARGO (quantity 9-12, depending on decisions made in C) are staged in the corresponding ALLIANCE STATIONS, split evenly (or off by one if an odd remainder) between the GAME PIECE Holders.

Additional GAME PIECES are staged as follows:

- One (1) CARGO is staged in each of the two (2) ALLIANCE WALL-facing CARGO SHIP BAYS
- Each team must prepopulate one (1) CARGO or one (1) Null HATCH PANEL (a HATCH PANEL marked with white tape and hardware installed to secure Null HATCH PANEL to the CARGO SHIP, see drawing GE-19244) in each of their two (2) designated CARGO SHIP BAYS (designated per the MATCH schedule and per Figure 5-2). Nonstaged Null HATCH PANELS and CARGO are excluded from MATCH play. If no team decision, the BAY will be populated with one (1) CARGO. **If order placement of GAME PIECES matters to either or both ALLIANCES, the ALLIANCE must notify the Head REFEREE during setup for that MATCH. Upon notification, the Head REFEREE will require ALLIANCES alternate placement of all GAME PIECES. In a Qualification MATCH, GAME PIECES will be placed in the following order: Blue Station 1, Red Station 1, Blue Station 2, Red Station 2, Blue Station 3, Red Station 3. In a PLAYOFF MATCH, the same pattern is applied, but instead of Red ALLIANCE placing last, the higher seeded ALLIANCE (regardless of color) places last.**



SECTION 5.3

Table 5-1 DESTINATION: DEEP SPACE scoring opportunities

Award	Awarded for...	Value
HATCH PANEL	each HATCH PANEL (excluding Null HATCH PANELS) attached to a ROCKET or CARGO SHIP such that it is fully supported by that ROCKET or CARGO SHIP and via the hook/loop tape (contact by an opponent ROBOT does not count as "support" and does not negate a scored HATCH PANEL). No more than one HATCH PANEL per HATCH will be counted.	2
CARGO	each CARGO (regardless of inflation state) in a BAY with a Null HATCH PANEL or scored HATCH PANEL and not in contact with a ROBOT from that ROCKET/CARGO SHIP'S ALLIANCE. No more than one CARGO per BAY will be counted.	3
HAB Climb Bonus: Level 1	each ROBOT which has climbed their HAB PLATFORM (value corresponds to the Level to which the ROBOT has climbed). A ROBOT that hasn't whose BUMPERS haven't fully crossed their HAB LINE to leave their HAB ZONE at any point during the MATCH isn't eligible.	3
HAB Climb Bonus: Level 2		6
HAB Climb Bonus: Level 3		12

SECTION 9.2.1

- H9. Between the (STARTING) LINES.** During the SANDSTORM PERIOD, COACHES, DRIVERS, and HUMAN PLAYERS, and any part of the OPERATOR CONSOLE may not break the vertical planes defined by the STARTING LINES, unless for safety purposes.

Exceptions are granted in cases concerning safety and for actions that are inadvertent, momentary, and inconsequential.

Violation: TECH FOUL.



Team Update 12

GENERAL

- **CAD:** [Autodesk's field models](#) have been updated to correct the vision target orientation described in [Team Update 08](#).
- **Control System:** An optional C++\Java WPILib Update has been released that fixes a number of bugs and makes a camera stream that switches between cameras easier. The update and full release notes can be found on the [Github Releases page](#).
- **Drawings:** The [Field Drawings – season specific](#) package includes an updated GE-19070. The note on sheet 6 has been updated to cover both types of net described in Section 4.4 below.
- **Inspection Checklist:** [Posted!](#)
- **Q&A:**
 - [Q202](#) has been edited to reflect the change to R35 below
 - [Q315](#) has been edited to reflect the change to Section 4.4 below.

MANUAL

SECTION 4.4

The back of each BAY is a cargo net (for side BAYS, the net is [Hall-Master, item no. 69618](#), square or diamond pattern, and for front BAYS, the net is [PowerTye, Part #50362](#)).

SECTION 10.6

- R35.** The integral mechanical and electrical system of any motor must not be modified. Motors, servos, and electric solenoids used on the ROBOT shall not be modified in any way, except as follows:
- A.** The mounting brackets and/or output shaft/interface may be modified to facilitate the physical connection of the motor to the ROBOT and actuated part.
 - B.** The electrical input leads may be trimmed to length as necessary and connectors or splices to additional wiring may be added.
 - C.** The locking pins on the window motors (P/N: 262100-3030 and 262100-3040) may be removed.
 - D.** The connector housings on KOP Automotive motors listed in Table 10-1 may be modified to facilitate lead connections.
 - E.** Servos may be modified as specified by the manufacturer (e.g. re-programming or modification for continuous rotation).
 - F.** The wiring harness of the Nidec Dynamo BLDC Motor may be modified as documented by *FIRST* in the ["Nidec Dynamo BLDC Motor with Controller" Screensteps article](#).
 - G.** Minimal labeling applied to indicate device purpose, connectivity, functional performance, etc.

The intent of this rule is to allow teams to modify mounting tabs and the like, not to gain a weight reduction by potentially compromising the structural integrity of any motor. The integral mechanical and electrical system of the motor is not to be modified.

Note that for the previous KOP Window motors and the Bosch motor, the gearbox is considered integral to the motor, thus the motor may not be used without the gearbox.



Team Update 11

MANUAL

SECTION 5.3

Table 5-1 DESTINATION: DEEP SPACE scoring opportunities

Award	Awarded for...	Value
HAB Climb Bonus: Level 1	each ROBOT which has climbed the their HAB PLATFORM (value corresponds to the Level to which the ROBOT has climbed). A ROBOT that hasn't fully crossed their HAB LINE to leave their HAB ZONE at any point during the MATCH isn't eligible.	3
HAB Climb Bonus: Level 2		6
HAB Climb Bonus: Level 3		12

SECTION 10.4

- R17.** All ROBOT elements (including items intended for use during the competition in alternative configurations of the ROBOT), with the exception of the WITHHOLDING ALLOWANCE per R23, **BUMPERS exceptions listed in R15**, and COTS items, must be bagged and sealed, by 04:59 UTC on Stop Build Day, Wednesday, February 20, 2019.

SECTION 10.6

- R37.** ² A CUSTOM CIRCUIT is any electrical COMPONENT of the ROBOT other than motors, pneumatic solenoids, roboRIO, PDP, PCM, VRM, RSL, 120A breaker, motor controllers, relay modules (per R36-B), wireless bridge, **electrical solenoid actuators**, or batteries.

SECTION 10.8

- R73.** The DRIVER Station software, roboRIO, Power Distribution Panel, Pneumatics Control Modules, Voltage Regulator Modules, RSL, 120A breaker, motor controllers, relay modules (per ~~R35-B~~ **R36-B**), Wireless Bridge, and batteries shall not be tampered with, modified, or adjusted in any way (tampering includes drilling, cutting, machining, rewiring, disassembling, painting, etc.), with the following exceptions: ...

SECTION 10.10

- R98.** The OPERATOR CONSOLE must not
- A.** be longer than 60 in. (~152 cm)
 - B.** be deeper than 14 in. (~35 cm) (excluding any items that are held or worn by the DRIVERS during the MATCH)
 - C.** extend more than 6 ft. 6 in. (~198 cm) above the floor
 - D.** attach to the FIELD (except as permitted by ~~G49~~ **G15**)

There is a 54 in. (~137 cm) long by 2 in. (nominal) wide strip of hook-and-loop tape ("loop" side) along the center of the PLAYER STATION support shelf that should be used to secure the OPERATOR CONSOLE to the shelf, per G15. See the [PLAYER STATION](#) section for details.

Please note that while there is no hard weight limit, OPERATOR CONSOLES that weigh more than 30 lbs. (~13 kg.) will invite extra scrutiny as they are likely to present unsafe circumstances.

SECTION 13

Term	Definition
CUSTOM CIRCUIT	any electrical COMPONENT of the ROBOT other than motors, pneumatic solenoids, roboRIO, PDP, PCM, VRM, RSL, 120A breaker, motor controllers, relay modules (per R36-B), wireless bridge, electrical solenoid actuators , or batteries



Team Update 10

MANUAL

SECTION 4.1

The long cable protector segment is a custom steel channel that is ~~$\frac{3}{4}$ in.~~ $\frac{7}{8}$ in. tall, 8 in. wide, and 3 ft. $11\frac{1}{8}$ in. long (~2 cm tall, ~20 cm wide, and ~120 cm long). It is secured to the carpet using hook fastener which increases the height to approximately ~~$\frac{3}{8}$ in. (~2 cm)~~ $1\frac{15}{16}$ in. (~2 cm). Exit segments are attached to the guardrail with hook fastener and are 6 in. tall, 8 in. wide and $2\frac{3}{4}$ in. deep (~15 cm tall, ~20 cm wide and ~7 cm deep).

SECTION 4.6

A rail is a $1\frac{1}{8}$ -in. (~3 cm) tall and ~~4 in. (~10 cm)~~ 3-in. (~8 cm) wide steel barrier that is attached to the ARENA carpet using 2-in. (~5 cm) wide 3M™ Hook Fastener SJ3572.



Team Update 09

GENERAL

- **Awards:** The Woodie Flowers Award content on the [Submitted Awards](#) webpage has revised *Entry Requirements* and *Entry Process* sections; the maximum number of allowed pictures changed from six to four.
- **Q&A Updates:** The answer to [Q237](#) has been edited to acknowledge that there are multiple top, upward facing surfaces for Level 1.



Team Update 08

GENERAL

- **VR Assets**
 - **From AutomationDirect:** You asked for it ... You got it ... A number of teams have requested the source files for the AutomationDirect VR Simulation so they can see how it was built and use it in their own projects. A link is now available at [here](#). Beware – it is HUGE - just under 6GB! Let us know if you do anything fun with it! FYI: It was built in UNREAL Engine using the Blueprint node-based programming. All assets were created in Blender.
- **Drawing Updates:** The [Team Version drawing packages](#) have been updated to correct a discrepancy between the Team Version LOADING STATION and the LOADING STATION on the official FIELD. The discrepancy leads to the HATCH PANEL being more difficult to remove from the Team Version than intended. See the drawing for TE-19108 for the corrected geometry of the part and an alternative fix that doesn't require the part to be recut.
- **Q&A Update:** [Q257](#) has been updated to reflect the change made to R12 below.

MANUAL

SECTION 4.8.1

Figure 4-25 has been updated to correct the orientation of the vision target tape on the left side LOADING STATION.

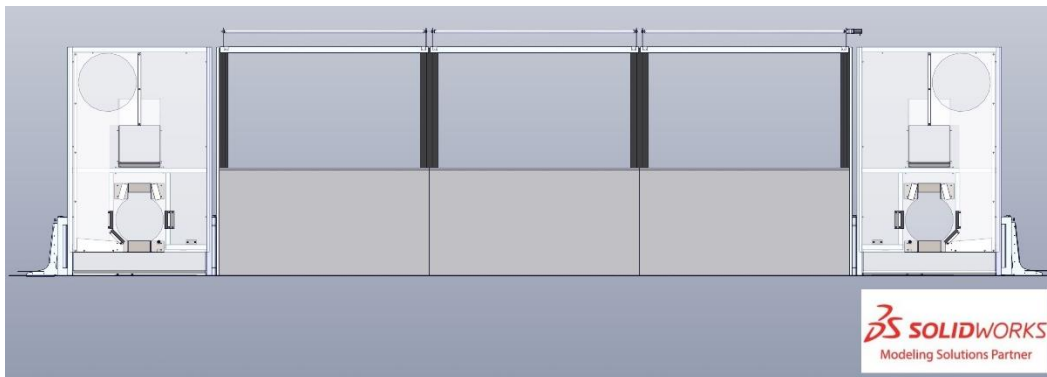

Figure 4-25 ALLIANCE WALL

SECTION 7

- C2. Be a good person.** All teams must be civil toward their team members, other team members, competition personnel, FIELD STAFF, and event attendees while at a *FIRST*[®] Robotics Competition event.

Violation: Behavior will be discussed with team or individual. Violations of this rule are likely to escalate to YELLOW or RED CARDS rapidly (i.e. the threshold for egregious or repeated violations is relatively low.)

Examples of inappropriate behavior include, but are not limited to, use of offensive language or other uncivil conduct.

We've learned that, although intended with no ill will, "clothes pinning" (a game played by some event participants where they try to clip a clothespin to an unsuspecting person) can and does make people uncomfortable. Understandable; it's unwelcome contact that may or may not have been from someone you know and trust. As a result, this is considered an example of uncivil conduct.

The activity known as 'the circle game' uses hand signals that can be negatively interpreted. As such, this game is considered an example of uncivil conduct.



SECTION 10.4

R12. The total cost of all items on the ROBOT shall not exceed \$5500 USD. All costs are to be determined as explained in the [Budget Constraints & Fabrication Schedule](#) section. Exceptions are as follows:

- A. individual items that are less than \$5 USD each, as purchasable from a VENDOR, and
- B. items from the current year's KOP, up to the KOP quantity (including the rookie KOP items). Identical **functional** replacements may be used to meet this criterion.

Teams should be prepared to disclose to Inspectors the cost of any non-KOP item and the total cost of the ROBOT. Teams should also be prepared to show that a particular item was received from *FIRST* Choice or a voucher in the current season if necessary.

Per I5, teams must be prepared to display a Bill of Material (BOM) to Inspectors during Inspection. The BOM may be displayed in either printed or electronic form.

Individual COMPONENTS or MECHANISMS, not excluded in R12, that are retrieved from previous ROBOTS and used on 2019 ROBOTS must have their un-depreciated cost included in the 2019 BOM and applied to the overall cost assessment.

Example 1: The Kickoff KOP checklist lists two (2) of motor controller XYZ in the Gray Tote distributed to rookie teams. Any team, including a veteran team that did not receive these items, can account for up to two (2) of them on the KOP checklist at a \$0 cost. Additional quantity of the same item would have to be accounted at the Fair Market Value.

Example 2: A team uses *FIRST* Choice credits, or a voucher, to acquire part ABC. This part, in the quantity obtained by the team via the KOP may be accounted at \$0. Additional quantity of the same item would have to be accounted at the Fair Market Value.

Example 3: Part ABC is available in *FIRST* Choice, but a team decides they have enough already on hand and does not acquire any through *FIRST* Choice. All of these items used on the ROBOT need to be accounted for at Fair Market Value as they did not come from the current year's KOP.

An "identical functional replacement" is an item which, to any reasonably astute observer, has the same form, fit, feature set, and function as the original component.

For example, any CIM motor can replace a CIM motor or a sheet of polycarbonate paid for completely by a voucher can be replaced with a sheet of polycarbonate of the same parameters (thickness, color, size, etc.). As another example, a motor controller that has the same form, fit, and function (i.e. controlling motors) as the original motor controller, but a different feature set (i.e. can communicate over CAN vs. the original controller which was PWM only) is not an identical functional replacement because the controllers' feature sets differ.



Team Update 07

MANUAL

SECTION 4.1

Each FIELD for DESTINATION: DEEP SPACE is a 27 ft. (~823 cm) by 54 ft. (~1646 cm) carpeted area bound by and including the inward-facing surfaces of the guardrails, inward-facing surfaces of the ALLIANCE WALLS (except Chute surfaces).

SECTION 10.5

- R28.** Each ROBOT must be able to display Red or Blue BUMPERS to MATCH their ALLIANCE color, as assigned in the MATCH schedule distributed at the event (as described in the [MATCH Schedules](#) section). BUMPER Markings visible when installed on the ROBOT, other than the following, are prohibited:
- A.** those required per R29,
 - B.** hook-and-loop fastener or snap fasteners backed by the hard parts of the BUMPER, and
 - C.** solid white *FIRST* logos between 4¾ in. (~12 cm) and 5¼ in. wide (~13 cm) (i.e. comparable to those available in the [2019 Virtual Kit](#)).

The FRAME PERIMETER facing surfaces of BUMPERS are not “displayed” and thus R28 does not apply.



Team Update 06

GENERAL

- **CAD/Drawing Package:** The [Official Field Models](#) and the [Official Field Drawings](#) (specifically GE-19150, GE-19153, and GE-19244) have been updated to show the correct shape of the loop tape on HATCH PANELS.
- **Bill of Material (BOM) Template:** published!
- **Robot Lockup Form:** published!
- **Radio Configuration Tool Update:** An updated version of the [FRC Radio Configuration Utility](#) (19.1.1) has been posted ([Israel version](#)) in the Screensteps [Programming your radio](#) article. This version corrects an issue with applying the Bandwidth Limit. Teams testing camera streams are advised to update and re-program their radios (there is no need to re-flash firmware).
- **VR Updates:**
 - AutomationDirect HTC Vive/Oculus Rift has updated their VR application ([link to info on FIRST's site](#), [link to AutomationDirect's page](#) which includes a video describing updates). In addition to fixing bugs, the new version allows users to drive a blue lift bot, press buttons to load GAME PIECES in the LOADING STATIONS, and preset the FIELD with GAME PIECES ("Start" doesn't reset the FIELD anymore).
 - NASA released a new version of [their Android viewer](#), the [RAP FRC Field Viewer](#). The update adds a "Non-VR" mode. This update accommodates users that don't have gyroscopes in their devices (which prevented them from being able to run the program previously) and use without a cardboard viewer. The user can use their left thumb on the corner of the screen to pan/tilt the camera and their right thumb to navigate forward/backward.

MANUAL

SECTION 4.10

Strips are angled toward each other at ~14.5 degrees with a tolerance of approximately ± 1 degree in respect to the part to which it's adhered (but please note, as stated earlier in this manual that "every effort is made to ensure that ARENAS are consistent from event to event. However, ARENAS are assembled in different venues by different event staff and some small variations occur") and such that there's an 8-in. (~20 cm) gap at their closest points.

SECTION 10.7

R60. All circuits shall be wired with appropriately sized insulated copper wire (SIGNAL LEVEL cables don't have to be copper):

Table 10-4 Breaker and Wire Sizing

Application	Minimum Wire Size
31 – 40A protected circuit	12 AWG (13 SWG or 4 mm ²)
21 – 30A protected circuit	14 AWG (16 SWG or 2.5 mm ²)
6 – 20A protected circuit Between the PDP dedicated terminals and the VRM or PCM Compressor outputs from the PCM	18 AWG (19 SWG or 1 mm ²)
Between the PDP and the roboRIO ≤5A protected circuit	22 AWG (22 SWG or 0.5 mm ²)
VRM 2A circuits	24 AWG (24 SWG or .25mm ²)
roboRIO PWM port outputs	26 AWG (27 SWG or 0.14 mm ²)



SIGNAL LEVEL circuits (i.e. circuits which draw $\leq 1A$ continuous and have a source incapable of delivering $>1A$, including but not limited to roboRIO non-PWM outputs, CAN signals, PCM Solenoid outputs, VRM 500mA outputs and Arduino outputs)

28 AWG
(29 SWG or .08 mm²)

SECTION 13

Term	Definition
ROBOT	an electromechanical assembly built by the <i>FIRST</i> Robotics Competition team to perform specific tasks when competing in DESTINATION: DEEP SPACE Presented By The Boeing Company. The ROBOT must include all of the basic systems required to be an active participant in the game – power, communications, control, BUMPERS, and movement. The ROBOT implementation must obviously follow a design approach intended to play DESTINATION: DEEP SPACE (e.g. a box of unassembled parts placed on the FIELD, or a ROBOT designed to play a different game, does not satisfy this definition).



Team Update 05

GENERAL

No updates

MANUAL

No updates



Team Update 04

GENERAL

- **Control System Update:** An optional NI Update Suite update (2019.1.0) has been released. This update:
 - contains a new roboRIO image (v13) that repairs an issue in interfacing with the Analog Devices IMU and Gyro boards in all languages (so, updating to this new image is needed for teams working with these sensors)
 - fixes a Driver Station issue with launching Smartdashboard and Shuffleboard automatically.
- **Q&A Updates:** [Q101](#) and [Q146](#) have been revised to reflect the revision to G4 described below. Please accept our apologies for any confusion.

MANUAL

SECTION 5.4

Table 5.2 DESTINATION: DEEP SPACE rule violations

Penalty	Description
FOUL	a credit of three (3) points towards the opponent's total score
TECH FOUL	a credit of ten (10) points toward the opponent's total score
YELLOW CARD	a warning issued by the Head REFEREE for egregious ROBOT or team member behavior or rule violations. A subsequent YELLOW CARD within the same tournament phase will lead to a RED CARD.
RED CARD	a penalty assessed for egregious ROBOT or team member behavior or rule violations which results in a team being DISQUALIFIED for the MATCH.
DISABLED	ROBOT is commanded to deactivate all outputs, rendering the ROBOT inoperable for the remainder of the MATCH.
DISQUALIFIED	the state of a team in which they receive zero (0) MATCH points and zero (0) Ranking Points in a Qualification MATCH or causes their ALLIANCE to receive zero (0) MATCH points in a Playoff MATCH

SECTION 8.2.2

- G4. One GAME PIECE at a time.** ROBOTS may not have extended or repeated control, i.e. exercise extended or repeated influence, of more than one (1) GAME PIECE at a time, either directly or transitively through other objects. A GAME PIECE that is at least partially supported by a ROCKET or CARGO SHIP is not considered controlled by the ROBOT.

Violation: FOUL per additional GAME PIECE. If greater than two (2) at a time, YELLOW CARD. If ROBOT releases all GAME PIECES, YELLOW CARD. If strategic, YELLOW CARD.

If a GAME PIECE becomes lodged in or on a ROBOT, it is considered controlled by the ROBOT. It is important to design your ROBOT so that it is impossible to inadvertently or unintentionally control more than the allowed maximum.

For Example, 1: if a ROBOT controls three (3) two (2) GAME PIECES and then releases them all in a way that both GAME PIECES are in scoring position, the team is issued two (2) FOULS (per part 1 of the violation), a YELLOW CARD for controlling more than two (2) GAME PIECES (per part 2 of the violation), and a second YELLOW CARD for releasing them all during the MATCH (per part 3 of the violation), thus earning a RED YELLOW CARD.

Example 2: If a CARGO is stuck on a ROBOT and that ROBOT picks up a HATCH PANEL, they are issued a FOUL per G4. If they place that HATCH PANEL and then pick up another HATCH PANEL, they are issued another FOUL. Continuing game play in this manner (i.e. not taking advantage of carrying more than one (1) GAME PIECE) would generally not be considered a strategic violation.



Example 3: A ROBOT controlling one (1) GAME PIECE that briefly contacts several CARGO in close proximity causing them to scatter would generally not be considered in violation of G4.

SECTION 10.5

R31.

- C. use a stacked pair of approximately 2½ in. (nominal) round, petal, or hex “pool noodles” (solid or hollow) as the BUMPER cushion material (see Figure 10-6). All pool noodles used in a BUMPER set (e.g. Red set of BUMPERS) may not be modified (with the exception of cutting to length or beveling ends) or deformed and must be the same diameter, cross-section, and density (e.g. all round hollow or all hex solid). Cushion material may extend up to 2½ in. (~63 mm) beyond the end of the plywood (see Figure 10-7). To assist in applying the fabric covering, soft fasteners may be used to attach the pool noodles to the wood backing, so long as the cross section in Figure 10-6 is not significantly altered (e.g. tape compressing the pool noodles).



Team Update 03

GENERAL

- **Control System:** An optional update has been released for WPILib for C++\Java, fixing a number of minor bugs discovered by teams in the first week of the season. Upgrade instructions and release notes detailing the changes can be found on the [release page](#).
- **VR Assets:** A new version of the [AutomationDirect HTC Vive/Oculus Rift application](#) has been posted. The new version allows users to control the CARGO SHIP to hold or eject CARGO, drive a ROBOT around the FIELD, and run a simulated MATCH. The SANDSTORM PERIOD has an active ROBOT camera view in the Driver Station computer.
- **Q&A:** [Q25](#) and [Q50](#) have been revised to reflect the clarification on SANDSTORM and HAB Climb Bonus assessments. Please accept our apologies for any confusion.

MANUAL

SECTION 5.1.1

Twenty-four (24) of each GAME PIECE are staged on each side of the FIELD ARENA for each MATCH as follows:

SECTION 5.3

For the purposes of assessing SANDSTORM and HAB Climb Bonuses described in Table 5-1, a ROBOT is considered to have started from, or climbed to, a HAB Level if:

1. the ROBOT'S BUMPERS are fully above the Level's platform,
2. the ROBOT is only supported by:
 - surfaces of the HAB PLATFORM at or above that Level,
 - ALLIANCE WALL, and/or
 - another ROBOT which has climbed to that HAB Level or higher

SANDSTORM and HAB Climb Bonuses are evaluated and scored by human REFEREES. Teams are encouraged to make sure that it's obvious and unambiguous that a ROBOT is not being supported by anything below that Level.

SECTION 8.2.2

- G4. One GAME PIECE at a time.** ROBOTS may not have extended or repeated control, i.e. exercise extended or repeated influence, of more than one (1) GAME PIECE at a time, either directly or transitively through other objects.

Violation: FOUL per additional GAME PIECE. If greater than two (2) at a time or second GAME PIECE leaves ROBOT, YELLOW CARD. If ROBOT releases all GAME PIECES, YELLOW CARD.

If a GAME PIECE becomes lodged in or on a ROBOT, it is considered controlled by the ROBOT. It is important to design your ROBOT so that it is impossible to inadvertently or unintentionally control more than the allowed maximum.

For example, if a ROBOT controls three (3) GAME PIECES and then releases them all, the team is issued two (2) FOULS (per part 1 of the violation), a YELLOW CARD for controlling more than two (2) GAME PIECES (per part 2 of the violation), and a second YELLOW CARD for releasing them all during the MATCH (per part 3 of the violation), thus earning a RED CARD.

- G6. No throwing HATCH PANELS.** ROBOTS may not shoot HATCH PANELS into the air in a way that's prohibited in R6, kick them across the floor using an active MECHANISM, or eject them across the floor in a forceful way (i.e. HATCH PANEL is propelled caused to move a significant distance).



SECTION 8.2.6

G24. Don't overextend yourself. ROBOTS may not extend more than 30 in (~76 cm). beyond their FRAME PERIMETER (see Figure 8-2).

Violation: FOUL. If strategic (e.g. expansion results in scoring a GAME PIECE), RED CARD.

Examples of compliance and non-compliance of G24 are shown in Figure 8-2.

Yellow bars represent the limits of the FRAME PERIMETER and are drawn in the same orientation of the ROBOT'S FRAME PERIMETER. Green bars represent a measured extension from the FRAME PERIMETER that has not been exceeded. Red bars represent a measured extension from the FRAME PERIMETER that has exceeded the limit in G24). ROBOTS A and C violate G24, whereas ROBOT B does not.

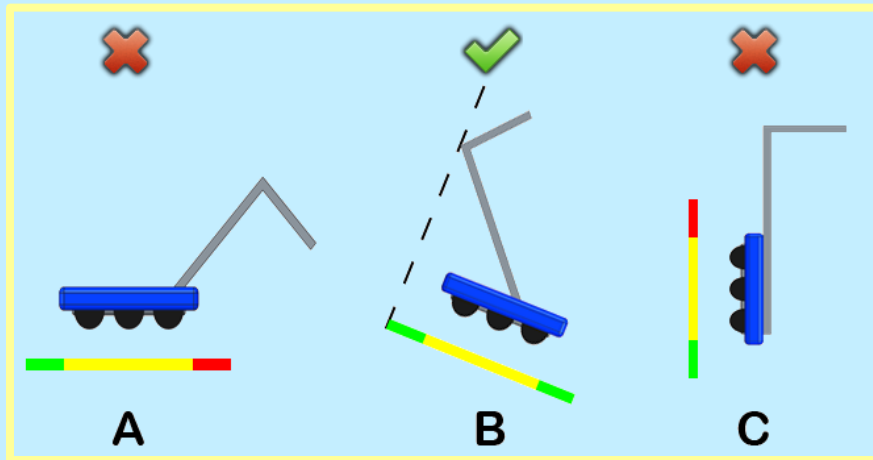

Figure 8-2 Examples of G24 compliance and non-compliance

SECTION 10.2

R3. (Blue Box)

~~Expect to have to demonstrate a ROBOT'S ability to constrain itself per above during Inspection. Constraints may be implemented with either hardware or software.~~

Be sure to consider the size of the ROBOT on its cart to make sure it will fit through doors. Also consider the size of the ROBOT to ensure that it will fit into a shipping crate, bag, vehicle, etc.

Note that the BUMPER Rules contained in the [BUMPER Rules section](#) may impose additional restrictions on ROBOT design

R4. (Blue Box)

~~Expect to have to demonstrate a ROBOT'S ability to constrain itself per above during Inspection. Constraints may be implemented with either hardware or software.~~

See the [Game Rules: ROBOTS](#) section for height and extension restrictions for various areas of the FIELD.

SECTION 10.3

R6. A ROBOT may not be designed to shoot a HATCH PANEL such that it travels more than 3 horizontal ft. (~91 cm) beyond its FRAME PERIMETER (reference G6).

The distance is measured with a stationary ROBOT relative to the ground and from the ROBOT'S FRAME PERIMETER to where the HATCH PANEL first contacts the ground. **At Inspection,**



Inspectors will expect teams to demonstrate compliance with R6 using the configuration and operation of the ROBOT that results in the farthest shot of a HATCH PANEL, i.e. the greatest distance of which the ROBOT is capable.

SECTION 10.4

- R13.** No individual, non-KOP item shall have a value Fair Market Value that exceeds \$500 USD. The total cost of COMPONENTS purchased in bulk may exceed \$500 USD as long as the cost of an individual COMPONENT does not exceed \$500 USD.
- R14.** The BOM cost of each non-KOP item must be calculated based on the unit Fair Market Value for the material and/or labor, except for labor provided by team members (including sponsor employees who are members of the team), members of other teams, event provided Machine Shops and shipping.

The Fair Market Value of a COTS part is its price defined by a VENDOR.

Example 1: A team orders a custom bracket made by a company to the team's specification. The company's material cost and normally charged labor rate apply.

Example 2: A team receives a donated sensor. The company would normally sell this item for \$52 USD, which is therefore its Fair Market Value.

Example 3: Special price discounts from National Instruments and other *FIRST* Suppliers are being offered to teams. The discounted purchase price of items from these sources may be used in the additional parts accounting calculations.

Example 4: A team purchases steel bar stock for \$10 USD and has it machined by a local machine shop. The machine shop is not considered a team Sponsor but donates two (2) hours of expended labor anyway. The team must include the estimated normal cost of the labor as if it were paid to the machine shop and add it to the \$10 USD.

Example 5: A team purchases steel bar stock for \$10 USD and has it machined by a local machine shop that is a recognized Sponsor of the team. If the machinists are considered members of the team, their labor costs do not apply. The total applicable cost for the part would be \$10 USD.

It is in the best interests of the teams and *FIRST* to form relationships with as many organizations as possible. Teams are encouraged to be expansive in recruiting and including organizations in their team, as that exposes more people and organizations to *FIRST*. Recognizing supporting companies as Sponsors of, and members in, the team is encouraged, even if the involvement of the Sponsor is solely through the donation of fabrication labor.

Example 6: A team purchases steel bar stock for \$10 USD and has it machined by another team. The total applicable cost for the part would be \$10 USD.

Example 7: A team purchases a 4 ft. by 4 ft. (~122 cm by 122 cm) sheet of aluminum, but only uses a piece 10 in. by 10 in. (~25 cm by 25 cm) on their ROBOT. The team identifies a source that sells aluminum sheet in 1 by 1 ft. (~30 cm by 30 cm) pieces. The team may cost their part based on a 1 by 1 ft. (~30 cm by 30 cm) piece, even though they cut the piece from a larger bulk purchase. They do not have to account for the entire 4 by 4 ft. (~122 cm by 122 cm) bulk purchase item.

Example 8: A team purchases a widget at a garage sale or online auction for \$3, but it's available for sale from a VENDOR for \$13. The Fair Market Value that gets reported on the BOM is \$13.

SECTION 10.5

R25.

Example 2: A ROBOT outside its HAB ZONE deploys a MECHANISM which lifts the BUMPERS outside the BUMPER ZONE (when virtually transposed onto a flat floor). This violates R25.

R31.



- B. hard BUMPER parts allowed per R31-A, -E, -F, and -G must not extend more than 1 in. (~25 mm) beyond the FRAME PERIMETER (measured as shown in Figure 10-4).

R31. (Blue Box 2)

All pool noodles used on a ROBOT must be the same in order to maintain the desired interaction between ROBOTS in the cases of BUMPER-to-BUMPER contact. BUMPERS containing pool noodles of vastly different construction may cause a “ramp” effect when interacting with other BUMPERS.

Noodle compression as a result of smoothing BUMPER fabric or rounding a FRAME PERIMETER corner is not considered deformed. Any compression beyond that, e.g. for the purposes of flattening the noodle, is deformation and a violation of R31-C.

- R31. (Figure 10-6, change is “optional aluminum metal angle attached with wood screws to clamp fabric” in callout)

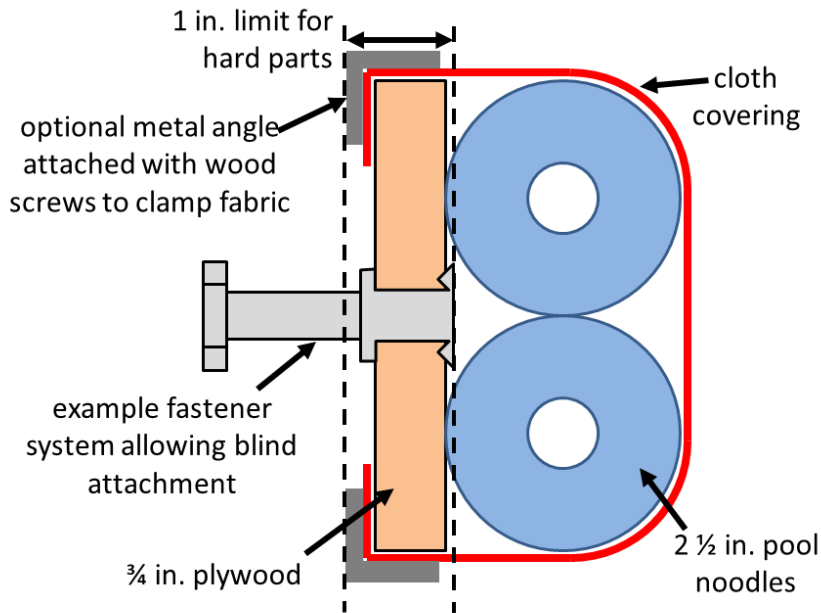

Figure 10-6 BUMPER Vertical Cross Section

- R32. (Figure 10-7, modified to better represent that the bottom right example is a noodle wrapped around the corner.)



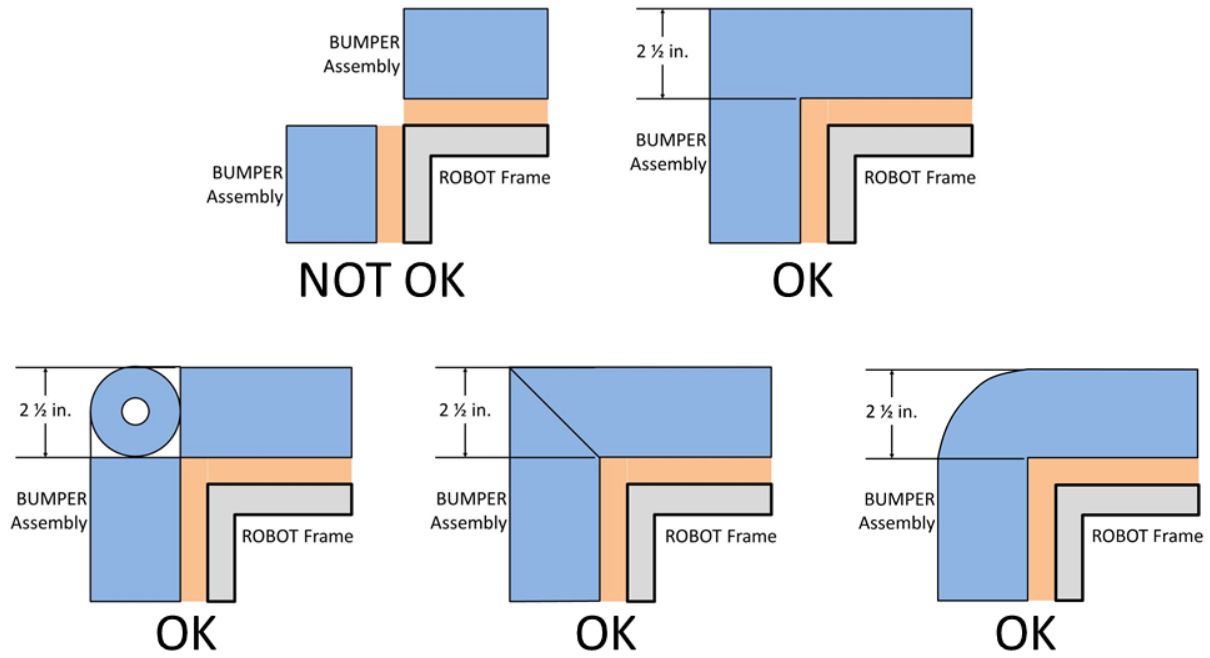

Figure 10-7 Soft Parts of BUMPER Corners

SECTION 10.9

R92.

- C. The two wires from the pressure switch must be connected directly to the pressure switch input of the PCM controlling the compressor or, if controlled using the roboRIO and a Spike relay, to the roboRIO.



Team Update 02

GENERAL

- A link to the [soft copy of the 2019 Virtual Kit Catalog](#) (printed copies were distributed in the Kickoff Kit) is posted in the [Virtual Kit section](#) of the [Kit of Parts page](#).
- GE-19126, GE-19127, GE-19165, GE-19166, and GE-19217 have been updated to include the information added to the gam manual's [Section 4.3](#), detailed below, and added to the [Field Drawings – season specific drawing package](#).

MANUAL

SECTION 4.3

Each ROCKET HATCH is flanked by two (2) 10 in. (~25 cm) tall, 2 in. (~ 5 cm) wide pieces of black hook tape (3M part number SJ3572), positioned as shown below.

SECTION 5.1.1

Twenty-four (24) of each GAME PIECES are staged on each side of the FIELD for each MATCH as follows:

SECTION 7

C8.

C8 does not apply for strategies consistent with standard gameplay, for example:

- a. causing an opponent ROBOT to contact your ROCKET during the last few seconds of a MATCH while in the process of trying to place a HATCH PANEL.
- b. contacting an opponent ROBOT while in your HAB ZONE while trying to retrieve CARGO from your DEPOT.

C8 requires an intentional act with limited or no opportunity for the TEAM being acted on to avoid the penalty, such as:

- c. placing a HATCH PANEL on/in an opponent who's already controlling a GAME PIECE such that they cannot help but violate G4.
- d. pushing an opponent ROBOT against your ROCKET during the final twenty (20) seconds of the MATCH for the sole purpose of making them violate ~~G9~~ G16.

SECTION 8.2.2

G6. No throwing HATCH PANELS. ROBOTS may not shoot HATCH PANELS into the air in a way that's prohibited in R6, kick them across the floor using an active MECHANISM, or eject them across the floor in a forceful way (i.e. HATCH PANEL is propelled a significant distance).

Violation: RED CARD.

SECTION 8.2.3

G14. Don't climb on each other unless in the HAB ZONE. A ROBOT may not be fully supported by a partner ROBOT unless the supporting ROBOT is at least partially in contact with its HAB ZONE.

SECTION 8.2.4

G15. Be careful about what you interact with. DRIVE TEAMS, ROBOTS, and OPERATOR CONSOLES are prohibited from the following actions with regards to interaction with ARENA elements. Items A-D exclude GAME PIECES and the HAB PLATFORM.

- A. Grabbing (excluding DRIVE TEAM interaction with FIELD elements in their areas)
- B. Grasping (excluding DRIVE TEAM interaction with FIELD elements in their areas)



- C. Attaching (including the use of hook tape to anchor to the FIELD carpet and excluding use of the PLAYER STATION hook-and-loop tape, plugging in to the provided power outlet, and plugging the provided Ethernet cable in to the OPERATOR CONSOLE)
- D. Hanging
- E. Deforming
- F. Becoming entangled
- G. Damaging

Violation: If prior to MATCH, and situation can be corrected quickly, it must be remedied before the MATCH will start. If during a MATCH, FOUL. If during a MATCH and extended or repeated, YELLOW CARD. If offense is via a ROBOT and the Head REFEREE determines that further damage is likely to occur, offending ROBOT will be DISABLED. Corrective action (such as eliminating sharp edges, removing the damaging MECHANISM, and/or re-Inspection) may be required before the ROBOT will be allowed to compete in subsequent MATCHES.

GAME PIECES are expected to undergo a reasonable amount of wear and tear as they are handled by ROBOTS, such as scratching or marking. Gouging, tearing off pieces, popping, or routinely marking GAME PIECES are violations of this rule. Materials that aggressively wear or leave behind residue or debris on the HATCH PANEL'S loop tape may hinder the natural behavior of the loop tape and thus violate G15. Humans causing GAME PIECE wear and tear, e.g. deforming a CARGO, are subject to a CARD per C1.

There are no rules that prohibit contact with the SANDSTORM'S black out material, however contact that prevents the SANDSTORM from working properly (e.g. retracting at T-minus 135s) is considered damaging and a violation of G15.

SECTION 10.2

- R1. The ROBOT (excluding BUMPERS) must have a FRAME PERIMETER, contained within the BUMPER ZONE and established in the ROBOT'S STARTING CONFIGURATION, that is comprised of fixed, non-articulated structural elements of the ROBOT. Minor protrusions no greater than ¼ in. (~6 mm) such as bolt heads, fastener ends, weld beads, and rivets are not considered part of the FRAME PERIMETER.

SECTION 10.3

- R6. A ROBOT may not be designed to launch shoot a HATCH PANEL such that it travels more than 2 3 horizontal ft. (~60 91 cm) beyond its FRAME PERIMETER (reference G6).

The distance is measured with a stationary ROBOT relative to the ground and from the ROBOT'S FRAME PERIMETER to where the HATCH PANEL first contacts the ground.



SECTION 10.6

R34. The only motors and actuators permitted on 2019 ROBOTS include the following (in any quantity):

Table 10-1 Motor allowances

Motor Name	Part Numbers Available	
CIM	FR801-001 M4-R0062-12 AM802-001A 217-2000 PM25R-44F-1005	PM25R-45F-1004 PM25R-45F-1003 PMR25R-45F-1003 PMR25R-44F-1005 am-0255
West Coast Products RS775 Pro	217-4347	
Banebots	am-3830 M7-RS775-18 RS775WC-8514	M5 – RS550-12 RS550VC-7527 RS550
AndyMark 9015	am-0912	
VEX BAG	217-3351	
VEX mini-CIM	217-3371	
AndyMark PG	am-2161 (alt. PN am-2765)	am-2194 (alt. PN am-2766)
KOP Automotive motors	Denso AE235100-0160 Denso 5-163800-RC1 Denso 262100-3030	Denso 262100-3040 Bosch 6 004 RA3 194-06
Snow Blower Motor	am-2235	
AndyMark NeveRest	am-3104	
AndyMark RedLine Motor	am-3775	am-3775a
Nidec Dynamo BLDC Motor	am-3740	DM3012-1063
REV Robotics NEO Brushless	REV-21-1650	
Electrical solenoid actuators, no greater than 1 in. (nominal) stroke and rated electrical input power no greater than 10 watts (W) continuous duty at 12 volts (VDC)		
Hard drive motors or fans that are: included in any Kickoff Kit, distributed via FIRST Choice, part of a legal motor controller (including manufacturer provided accessories), or part of a legal COTS computing device		
Factory installed vibration and autofocus motors resident in COTS computing devices (e.g. rumble motor in a smartphone).		
PWM COTS servos with a retail cost < \$75.		
Motors integral to a COTS sensor (e.g. LIDAR, scanning sonar, etc.), provided the device is not modified except to facilitate mounting		
One (1) compressor compliant with R86 and used to compress air for the ROBOT'S pneumatic system		

SECTION 10.9

R84. The only pneumatic system items permitted on ROBOTS include the items listed below.

A. Pneumatic pressure vent plug valves functionally equivalent to those provided in the KOP,

Parker valves PV609-2 or MV709-2 are recommended.

B. Pressure relief valves functionally equivalent to those provided in the KOP,

Norgren 16-004-011, 16-004-003 or McMaster-Carr 48435K714 recommended.

To be considered functionally equivalent the valve must be preset or adjustable to 125 psi (~862 kPA) and capable of relieving at least 1 scfm (~472 cm³/s).

C. Solenoid valves with a maximum 1/8 in. (nominal, ~3 mm) NPT, BSPP, or BSPT port diameter or integrated quick connect 1/4 in. (nominal, ~6mm) outside diameter tubing connection,

D. Additional pneumatic tubing, with a maximum 1/4 in. (nominal, ~6 mm) outside diameter,



- E. Pressure transducers, pressure gauges, passive flow control valves (specifically “needle valve”), manifolds, and connecting fittings (including COTS pneumatic U-tubes),
- F. Check and quick exhaust valves, provided that the requirements of **Error! Reference source not found.** are still met.
- G. Shutoff valves which relieve downstream pressure to atmosphere when closed (may also be known as 3-way or 3-way exhausting valves).
- H. Pressure regulators with the maximum outlet pressure adjusted to no more than 60 psi (~413 kPa),
- I. Pneumatic cylinders, pneumatic linear actuators, and rotary actuators,
- J. Pneumatic storage tanks (with the exception of White Clippard tanks P/N: AVT-PP-41),
- K. One (1) compressor that is compliant with R86, ~~and~~
- L. Debris or coalescing (water) filters, ~~and~~
- M. Venturi valves (note: the high-pressure side of a Venturi valve is considered a pneumatic device and must follow all pneumatic rules. The vacuum side of a Venturi valve is exempt from the pneumatic rules per “a” in the Blue Box below).

The following devices are not considered pneumatic devices and are not subject to pneumatic rules (though they must satisfy all other rules):

- a. a device that creates a vacuum
- b. closed-loop COTS pneumatic (gas) shocks
- c. air-filled (pneumatic) wheels
- d. pneumatic devices not used as part of a pneumatic system (i.e. used in a way that does not allow them to contain pressurized air)

SECTION 12.2.1

During the Playoff MATCHES, if a team receives a YELLOW or RED CARD, it results in for the their entire ALLIANCE receiving the YELLOW or RED CARD for that MATCH. If different teams on the same two (2) YELLOW CARDS are accrued by an ALLIANCE are issued YELLOW CARDS, the entire ALLIANCE is issued a RED CARD.



Team Update 01

GENERAL

- **CAD Models:** [The official CAD models](#) have been updated per the changes described in this document and also to correct errors users may have experienced in accessing files for parts that get a vinyl overlay.
- **Control System:** As you dive into programming your robot, we want to point out two pages of the Screensteps documentation you may want to pay particularly close attention to. The [New for 2019!](#) page outlines major software changes for the 2019 season, including information about 2019 Game Specifics such as how the Sandstorm is handled in robot code. The [Known Issues](#) page documents major issues we are currently aware of along with workarounds or solutions where available.

KICKOFF KIT CHECKLIST: BLACK TOTE

V1 of the [Black Tote Checklist](#) has been updated to include the following edit:

Seat Motor
w/ connector, cable

Bosch

6004 RA3 194-
06 1

n/a
www.andymark.com



2019 VIRTUAL KIT CATALOG

Consider marking up your *2019 Virtual Kit Catalog* packed in your Black Tote with the following edits:

- **Inventables:** Use the voucher code as a gift certificate code in the "Enter Promotion" field on the shopping cart page.
- **Next Gen Robots:** Voucher Detail: CIM Cooler 180 or 775 Cooler 360
- **Wolfram:** Access Codes: Visit Team Registration Account (Lead Mentor 1 or 2) sent via email after completing webform

VIRTUAL REALITY (VR) ASSETS

VR assets have been updated as follows:

- [AutomationDirect HTC Vive/Oculus Rift Asset](#): The color of cargo ships has been corrected.
- [PTC](#): The [VuMark pdf](#) (for use with the [Scaled VR model](#)) has been updated to remove unnecessary "with ThingMark" language.

MANUAL

SECTION 4.1

A run of steel, black powder coated cable protectors (VEX part number 217-6294) extends from the center of the guardrail on the scoring table side of the FIELD to the center of the FIELD, between the CARGO SHIPS. A cable protector run is made up of three (3) long segments (P/N) and an exit segment (P/N note, the exit segments are not available for purchase).



SECTION 4.4

- Figure 4-16 has been added (please note, this addition rennumbers all subsequent images in Section 4).

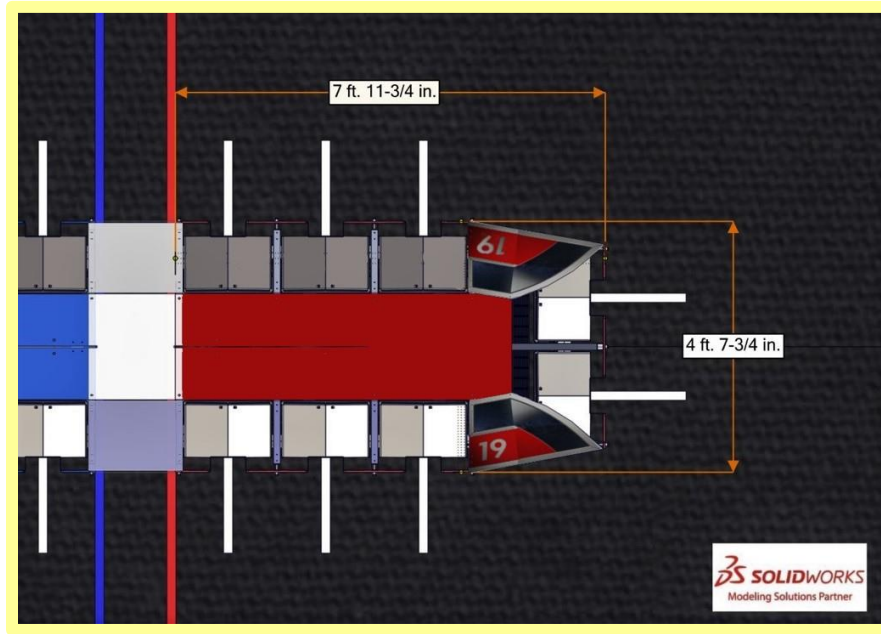

Figure 4-16 Overall CARGO SHIP length and width.



- Figure 4-17 (formerly Figure 4-16) has been updated to correct the length and width of the CARGO SHIP base.

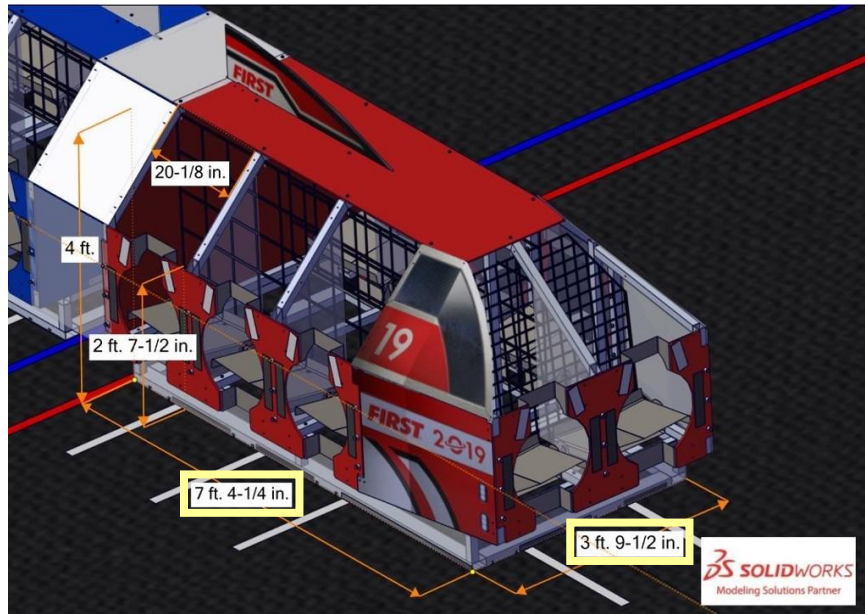

Figure 4-17 Major CARGO SHIP dimensions.

- Figure 4-18 (formerly Figure 4-17) has been updated as follows:

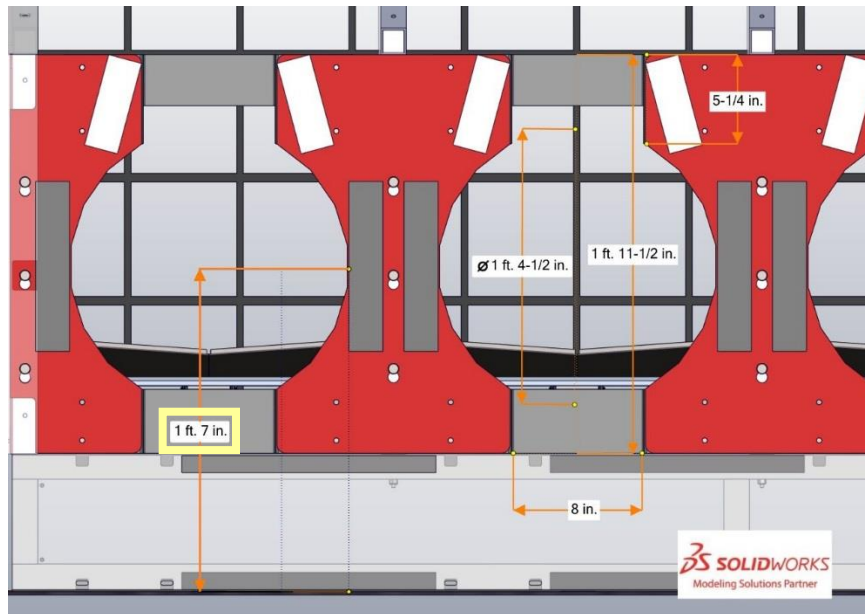

Figure 4-18 CARGO SHIP HATCH geometry and dimensions.



SECTION 4.5

Figure 4-21 (formerly Figure 4-20) has been updated to correct the width and depth of the lowest deck and ramps.

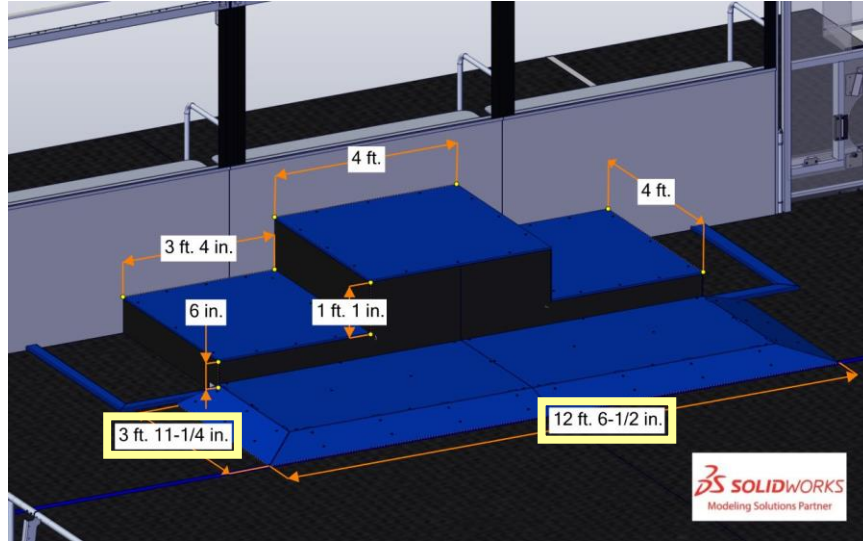

Figure 4-21 Blue HAB PLATFORM with major dimensions.

SECTION 4.6

Figure 4-23 (formerly Figure 4-22) has been updated to correct the width and depth of the DEPOT.

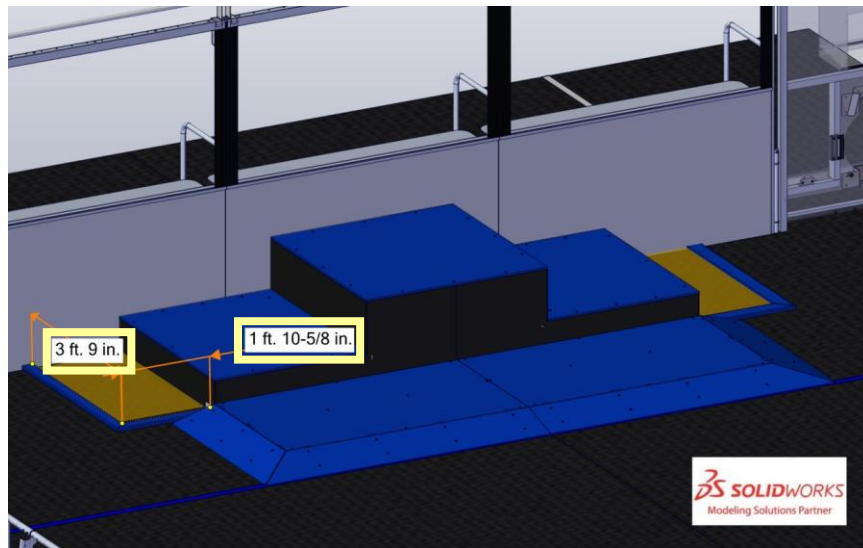

Figure 4-23 Blue DEPOTS

SECTION 4.8.1.1

Three (3) in. (~7.6 cm) of black tape is applied to the left and right edges of the PLAYER STATION polycarbonate window, on the FIELD side.

Figure 4-26 (formerly Figure 4-25) has been updated to show the wider taped area (as have other affected images in the manual, [CAD models](#), and the [Layout and Marking Diagram](#)):





Figure 4-27 Tape on PLAYER STATION window

SECTION 4.8.1.2

Figure 4-28 (formerly Figure 4-27) has been updated to correct the width of the LOADING STATION.

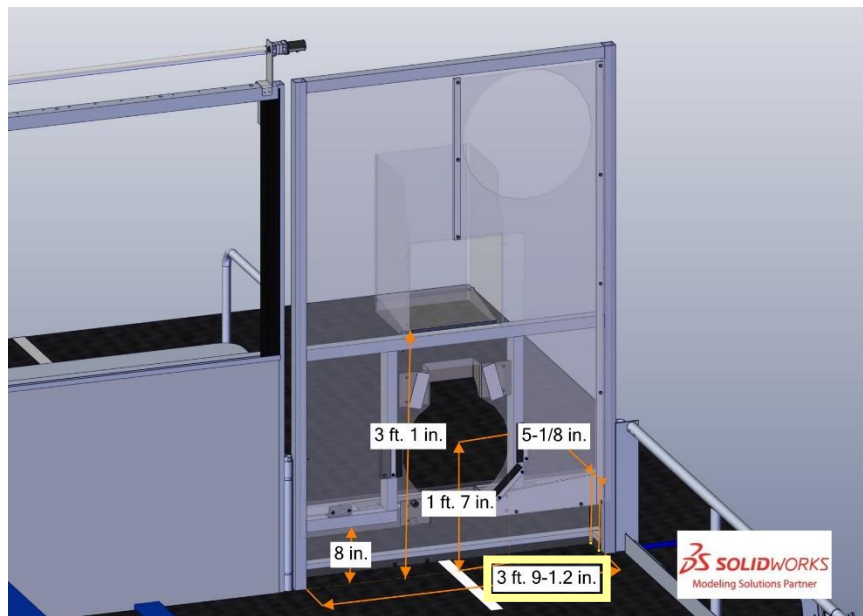

Figure 4-28 LOADING STATION

SECTION 4.9.1

Each CARGO is an orange 13-in. (~33 cm) $\pm\frac{1}{2}$ in. (~1.2 cm) diameter rubber playground ball with a FIRST logo as shown in Figure 4-29 Figure 4-30.

SECTION 5.5

While the TECHNICIAN may be the primary technical member of the DRIVE TEAM, all members of the DRIVE TEAM are encouraged to have knowledge of the basic functionality of the ROBOT, such as the location and operation of the main circuit breaker, connecting and resetting joysticks or gamepads from the OPERATOR CONSOLE, and releasing removing the ROBOT from the SCALEHAB PLATFORM.



SECTION 6

- S2. Wait for the green lights.** Team members may only enter the **FIELD** if the ROCKET'S nosecone LEDs are green, unless explicitly instructed by a REFEREE or an FTA.

SECTION 8.2.2

- G5. Don't mess with opponents' scored GAME PIECES.** A ROBOT may not remove a GAME PIECE from an opponents' ROCKET/CARGO SHIP. GAME PIECES which become dislodged because of incidental contact with the ROCKET/CARGO SHIP are not considered a violation of this rule.

*Violation: FOUL per GAME PIECE de-scored and opponents are awarded one (1) **Complete ROCKET** Ranking Point if neither of their ROCKETS are completed at T-minus 0s.*

SECTION 8.2.4

- G16. Don't touch opponents' ROCKETS at the end of the MATCH.** During Qualification MATCHES, ROBOTS may not contact opponents' ROCKETS starting at T-minus 20s. Incidental contact, i.e. unintentional contact where opponents' actions are not impeded (e.g. minor contact while driving by the ROCKET), is an exception to this rule.

*Violation: FOUL and opponents are awarded one (1) **Complete ROCKET** Ranking Point if neither of their ROCKETS are completed at T-minus 0s.*

SECTION 10.4

A note about the change to R12: We regret the oversight of not informing teams of the changes to the cost limit and KIT OF PARTS definition before the Drive Base Opt Out window and *FIRST* Choice Round 1.

We're sorry.

As a result, we're modifying R12 to compensate, if only partially, for the fact that teams may have made different decisions in the fall given the change to the rules.

- R12.** The total cost of all items on the ROBOT shall not exceed ~~\$5000~~ **\$5500** USD. All costs are to be determined as explained in the [Budget Constraints & Fabrication Schedule](#) section. Exceptions are as follows:
- A.** individual items that are less than \$5 USD each, as purchasable from a VENDOR, and
 - B.** items from the current year's KOP, up to the KOP quantity (including the rookie KOP items). Identical replacements may be used to meet this criterion.

SECTION 10.9

- R86.** Throughout an event, compressed air on the ROBOT must be provided by its one **onboard** compressor **only**. Compressor specifications must not exceed nominal 1.10 cfm (~319 cm³/s) flow rate @ 12VDC.

SECTION 12.7

Table 12-3 was updated as follows:

Table 12-3 Playoff MATCH Tiebreaker Criteria

Order Sort	Criteria
1 st	Cumulative FOUL and TECH FOUL points due to opponent rule violations
2 nd	Cumulative CARGO points
3 rd	Cumulative HATCH PANEL points
4 th	Cumulative HAB CLIMB points
5 th	Cumulative SANDSTORM BONUS points
6 th	MATCH is replayed

SECTION 12.8.3

Some District Championships have a sufficient number of teams to justify using more than one division. Teams are assigned divisions by ~~event organizers~~ **FIRST** using a process developed by *FIRST* in Michigan.

The process employs a "brute force iterative randomizer" and is executed as follows:



1. The district team list is sorted in order of cumulative district points earned as described in the District Events section.
2. The list is divided into quartiles based on rank (e.g. the 1st quartile has the top 25% ranked teams)
3. Division assignments are randomly generated using equal contribution from each quartile
4. Three (3) criteria are calculated for each division:
 - a. Average strength: The arithmetic mean of the district point values of teams in a division
 - b. Distribution of strength: The Signal to Noise Ratio (SNR) of the district point values of teams in a division. SNR is calculated as follows:

$$SNR = 10(\log \frac{\bar{x}^2}{\sigma^2})$$

\bar{x} = arithmetic mean of the district points in a division

σ = standard deviation of the district points in a division

- c. Distribution of strength for “top” teams: The SNR of the district point values of teams in the 1st quartile of a division.
5. The three (3) criteria for each division are compared to the other division(s). If the difference between the division’s value and any other division’s value exceeds the limits in Table 0-1, the criteria is not met.

Table 0-1 District Championship Division Evaluation Limits

	Two (2) Divisions	Four (4) Divisions
Average strength	1	2
Distribution of strength	1	2.5
Distribution of strength for “top” teams	1.5	2

6. If all three (3) criteria met, event organizers publish the assignments. If any of the three (3) criteria are not met, assignments are rejected, and the process returns to Step 3.

In these cases:

- Division winning ALLIANCES play each other in District Championship Playoffs, employing the bracket below that corresponds to their District, until a winning ALLIANCE for the event is determined.

